

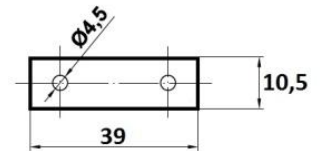

SOPORTE FINAL

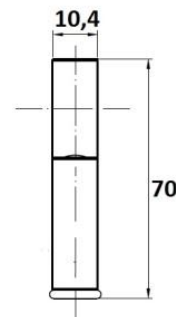
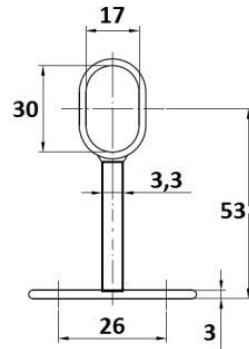

Características

Soporte final para barra ovalada de armario 30x15mm

Fabricado en zamak

Acabados

Níquel

Sistema de fijación

La fijación se realiza mediante tirafondos

Embalaje

Envase: 75 uds

Embalaje: 375 uds

Garantía

BrassOcho s.a. ha incorporado en su sistema de producción los procedimientos de la norma UNE EN ISO 9001.

RECEPCIÓN DE PEDIDO-PRODUCCIÓN-INSPECCIÓN-ENSAYO Y TRAZABILIDAD-EXPEDICIÓN-FEEDBACK

Para ello, cuenta con proveedores homologados y con su propio sistema de mejora. Esta garantía ampara los productos BRASSOCHO siempre y cuando se observen las condiciones de montaje, uso y mantenimiento correctas y cuando no sean alteradas las características físico-químicas del producto.



SUPOORTE FINAL

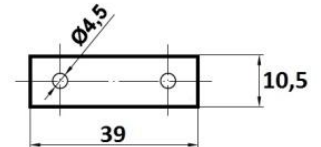
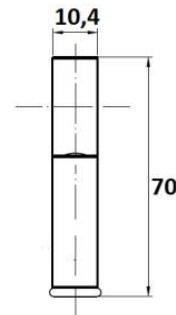
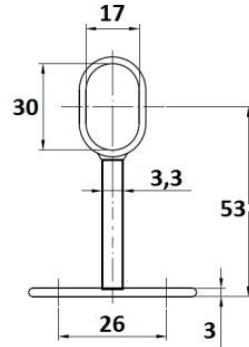

Características

Suporte final para tubo oval de roupeiro 30x15 mm

Fabricado em zamak

Acabamentos

Níquel

Sistema de fixação

Fixação por parafusos

Embalagem

Unidade: 75 unidades

Caixa: 375 unidades

Garantia

A BrassOcho S.A. integrou no seu sistema de produção os procedimentos da norma UNE EN ISO 9001.

RECEÇÃO DE ENCOMENDAS – PRODUÇÃO – INSPEÇÃO – ENSAIOS E RASTREABILIDADE – EXPEDIÇÃO – FEEDBACK

Para tal, conta com fornecedores homologados e com um sistema próprio de melhoria contínua. Esta garantia cobre os produtos BRASSOCHO desde que sejam respeitadas as condições corretas de montagem, utilização e manutenção, e não sejam alteradas as características físico-químicas do produto.



SUPPORT TERMINAL

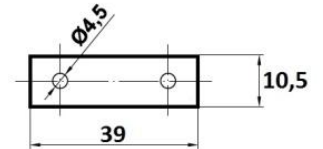
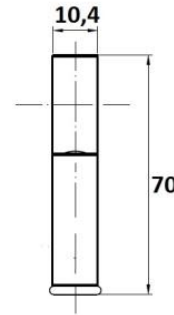
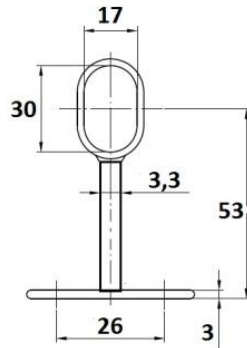

Caractéristiques

Support terminal pour barre ovale de penderie 30x15 mm

Fabriqué en zamak

Finitions

Nickel

Système de fixation

Fixation par vis

Emballage

Unité : 75 pièces

Carton : 375 pièces

Garantie

BrassOcho S.A. a intégré dans son système de production les procédures de la norme UNE EN ISO 9001.

RÉCEPTION DE COMMANDE – PRODUCTION – CONTRÔLE – ESSAIS ET TRAÇABILITÉ – EXPÉDITION – RETOUR D'INFORMATION

Pour cela, elle travaille avec des fournisseurs homologués et dispose de son propre système d'amélioration continue. Cette garantie couvre les produits BRASSOCHO à condition que les conditions correctes de montage, d'utilisation et d'entretien soient respectées, et que les caractéristiques physico-chimiques du produit ne soient pas altérées.



END SUPPORT

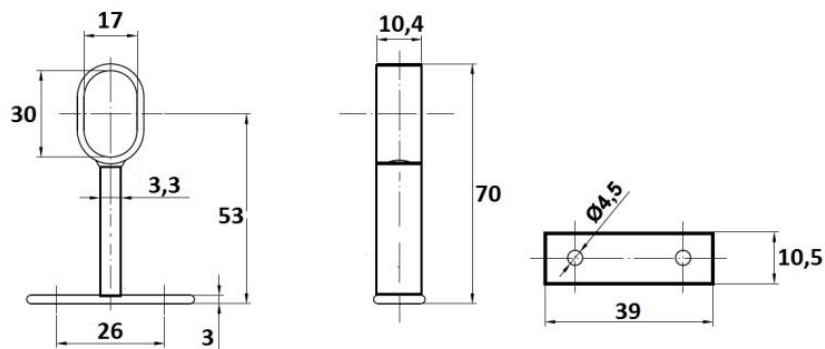

Features

End support for oval wardrobe rail 30x15 mm

Made of zamak

Finishes

Nickel

Fixing system

Fixed with screws

Packaging

Unit pack: 75 units

Master pack: 375 units

Warranty

BrassOcho S.A. has incorporated the procedures of the UNE EN ISO 9001 standard into its production system.

ORDER RECEPTION – PRODUCTION – INSPECTION – TESTING AND TRACEABILITY – DISPATCH – FEEDBACK

To this end, it works with approved suppliers and has its own continuous improvement system. This warranty covers BRASSOCHO products as long as proper installation, use, and maintenance conditions are followed and the product's physical and chemical properties are not altered.